

Multi-Level Inverter with Simplified Control Strategy for Distributed Energy Resource Integration with Distribution System

K.Naresh

Electrical Department, Usha Rama College of Engineering, Vijayawada, India

Abstract : Distributed generation (DG) provides stability to system reducing the power generation from plants running with fossil fuels. With the advancements in power electronics, integration of distributed generation became simple and cost effective. This paper illustrates the scheme of integrating of photo-voltaic (PV) system as distributed generation to micro-grid. PV system is integrated to grid with three-level inverter and five-level cascaded H-Bridge inverter to invert the type of supply synchronized to grid. Inverter will be controlled with simple current control strategy. Results were presented for the proposed work considering cases like DG sending only active power and DG injecting both active and reactive power through three-level and five-level inverter topologies. Total harmonic distortion in source current and voltage of grid reduce when using multi-level topology. Rate of change in voltage also reduces resulting in reduced filters when level at output of inverter is increased.

Keywords - Distributed generation (DG), integration, photo-voltaic (PV), three-level, five-level.

I. INTRODUCTION

Micro-grid structure is phenomenal in the area of power systems possibility with the advancements in power electronics. Micro-grid is a smallest version of general power grid involving with and without synchronizing to main grid. Traditional main grids comprises of transmission and distribution of power generated to loads, but micro-grid gives very less proximity of generation to load increasing the system efficiency and reducing losses. Micro-grid involves in providing generation, local reliability, storage management and stability to local area where micro-grid is considered. Micro-grid generally is a combination of several distributed generations (DG) with loads operating with and without connection to main grid [1-2]. Fossil fuels can generate electrical power in bulk but emission of green house gases is the global issue these days with using conventional fossil fuels. To reduce the carbon gases emission from conventional power plants, renewable energy sources is the best alternative to provide stability to power system reducing the power generation from conventional plants. Photo-voltaic (PV) system [3-4], wind system, fuel-cells are examples used in renewable sources for power generation. PV system is one of the forefront generation scheme employed in major. PV cell is a simple P-N junction layer to produce potential barrier between the two layers. Photon from the light energy when absorbed by the charge carriers in PV cell, electrons starts flowing and giving rise to current flow [5-6].

Integration of PV system to grid requires an interfacing converter along with interfacing inductors. Interfacing converter is generally an inverter or a voltage source converter (VSC). Typical PV based micro-grid integration to main grid was shown in figure 1. Conventional square wave inverter gives out output with infinite harmonics which needs high sizing of filter at the output of inverter. Increasing the level of output at the inverter can reduce the total harmonic distortion in inverter output eventually reducing the size of filter. Multi-level topology if inverters give better quality of output result reducing the cost of the system [7-8].

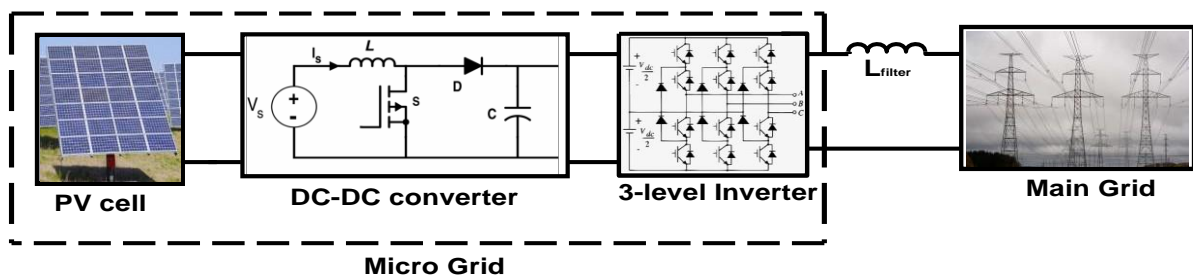

Figure 1: Typical PV based system integration to main grid

This paper presents PV system integration to micro-grid through multi-level topology as interfacing converter. Three-level and five-level inverters are validated for interfacing PV system to grid. 3-level and 5-level inverters are controlled with simple current control strategy. Different cases are considered like PV system delivering only active power and sending both active and reactive powers to the grid and results were presented using MATLAB/SIMULINK software.

II. PV SYSTEM INTEGRATION TO GRID THROUGH THREE-LEVEL INVERTER TOPOLOGY

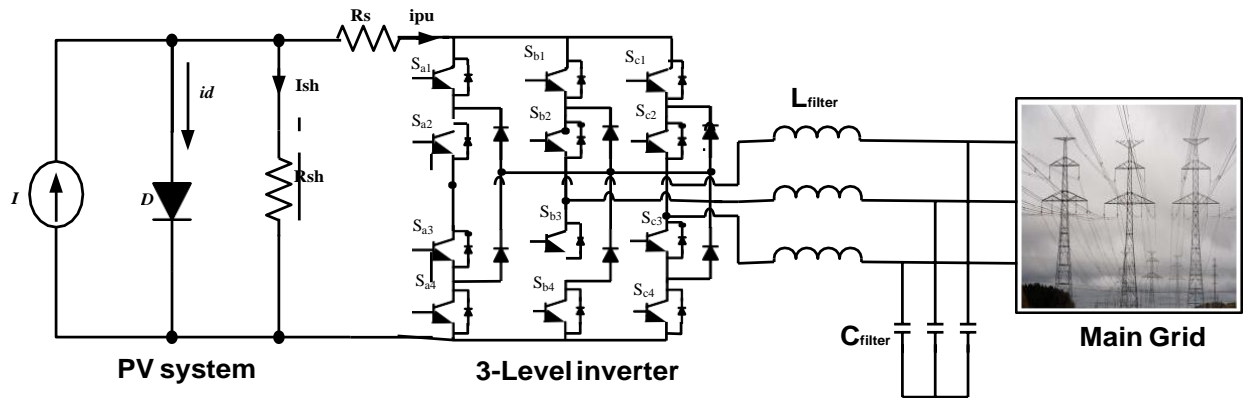

Figure 2: PV cell based 3-level inverter integration with micro grid.

The schematic arrangement of PV system integration to grid with 3-level inverter topology is shown in figure 2. A PV system equivalent was shown and is connected to 3-level inverter. The output from PV system is generally of DC type and for integration PV system to grid; output from PV system is to be inverted to alternating type. A 3-level inverter is a power electronic converter inverting the input DC supply to AC output. A 3-level inverter produces three level output when compared to two-level from conventional square wave inverter. The output of inverter is now passed through a filter to eliminate the distortions in source voltage and current. As the number of output level from the inverter is increased, total harmonic distortion at the output of inverter reduces with less filter needed.

III. PV SYSTEM INTEGRATION TO GRID WITH 5-LEVEL CHB INVERTER

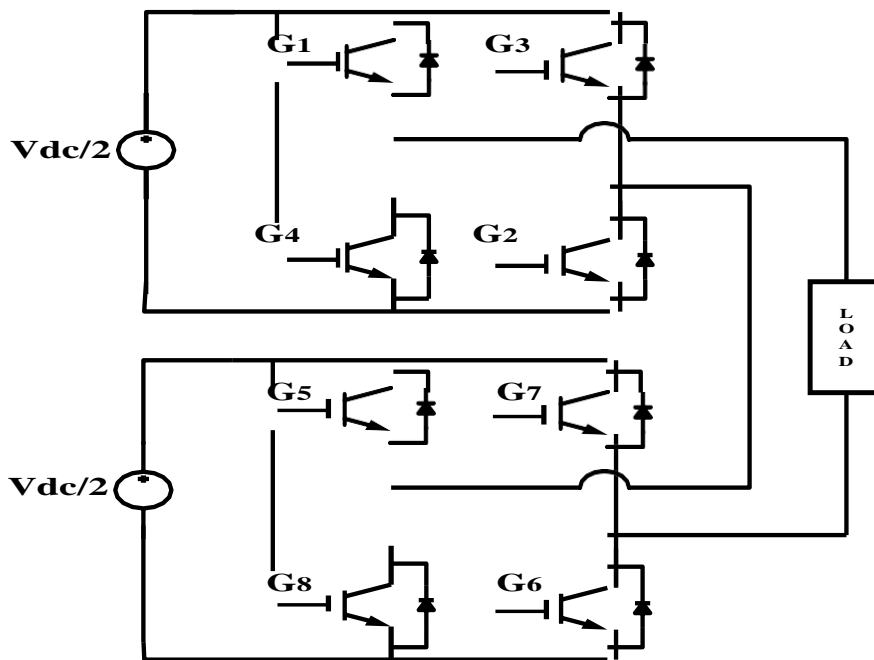

Figure 3: 5-level CHB inverter topology per phase

Cascade H-Bridge (CHB) topology of multi-level inverters is one of the simple topologies in inverters and a five-level CHB topology per phase was shown in figure 3. Inverter is constructed with number of H-shaped bridges and each bridge consisting of four power switches. Depending on the number of output level of inverter, number of cascade bridges depends. For a five-level CHB inverter, two H-bridges are cascaded per phase. No two switches of same leg in an H-bridge should be turned ON at a time to avoid short-circuit conditions. Sequential switching of switches in cascaded H-bridge topology, five level output is obtained at the output of inverter. The switching pattern of a cascaded H-bridge inverter to obtain five-level output is illustrated in table-1.

Table-1: Switching pattern in 5-level CHB inverter

Voltage	Switching operation							
level	G1	G2	G3	G4	G5	G6	G7	G8
0	1	0	1	0	1	0	1	0
Vdc/2	1	1	0	0	1	0	1	0
Vdc	1	1	0	0	1	1	0	0
-Vdc/2	0	0	1	1	1	0	1	0
-Vdc	0	0	1	1	0	0	1	1

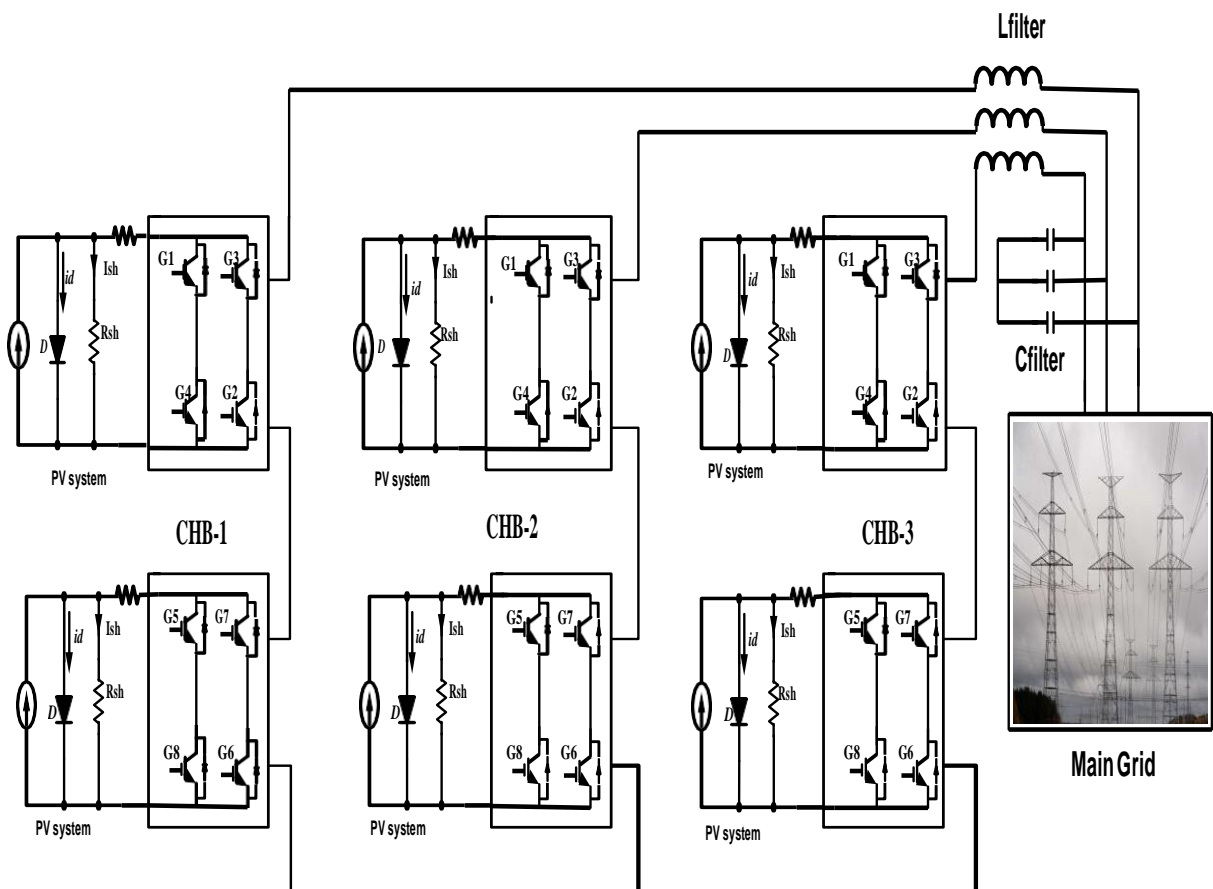

Figure 4: PV system integration to grid with three-phase CHB inverter

Connecting two H-bridges in cascade per each phase for 5-level inverter topology gives 5-level output. Similar connection of another two CHBs constitutes three-phase 5-level CHB topology as shown in figure 4. A

DC voltage is required to drive individual H-bridge. Replacing a DC source with a PV equivalent can drive CHB as shown in figure. PV equivalent is connected in each of the H-bridge and the three-phase inverted output will be present at the output in 5-level stepped fashion. The output of inverter still consists of harmonic distortions and thus by passing the output of inverter through filter, distortion in currents and voltages are reduced and sent to the main grid via interfacing inductors.

IV. CONTROL SCHEME FOR INVERTERS

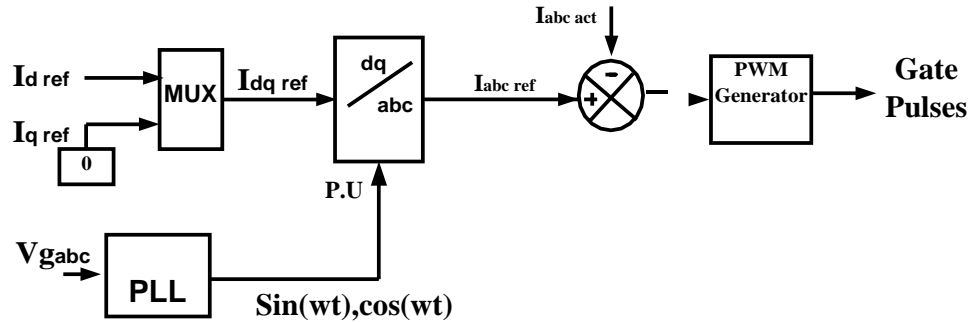

Figure 5: Control block diagram for inverters

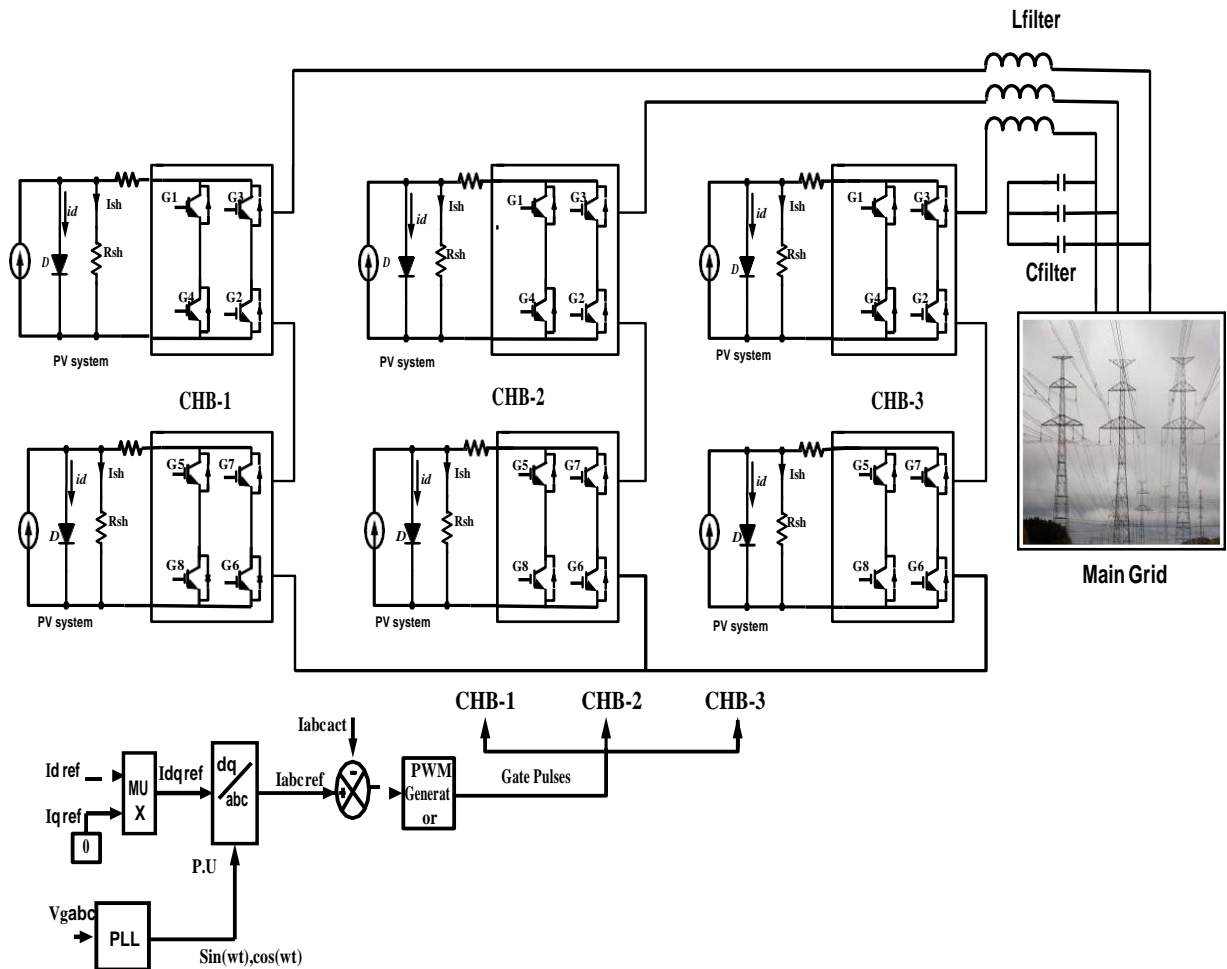

Figure 6: Complete schematic arrangement of PV integration to grid through multi-level inverter with control block

The control block diagram producing triggering pulses to the inverter was shown in figure 5. Simple current control strategy was considered to produce triggering pulses to the inverter power switches. A simple strategy ‘d’ component of current and ‘q’ component of current are combined to form ‘dq’ component of reference current. The reference ‘dq’ component of current along with the information of current shape from phase-locked loop is

transformed from 'dq' to 'abc' components producing three-phase reference currents. This reference current compared to actual currents produces error and the error signal is given to PWM generator to produce pulses for switches of CHB inverter. The complete schematic arrangement of PV system integration to grid through five-level CHB topology was illustrated in figure 6.

V. RESULTS AND DISCUSSIONS

Results were presented by considering different cases like PV system delivering active power to distribution grid and sending both active and reactive power to distribution grid through three-level and five-level inverter topologies.

Case 1: PV system integration sending only active power through three-level topology

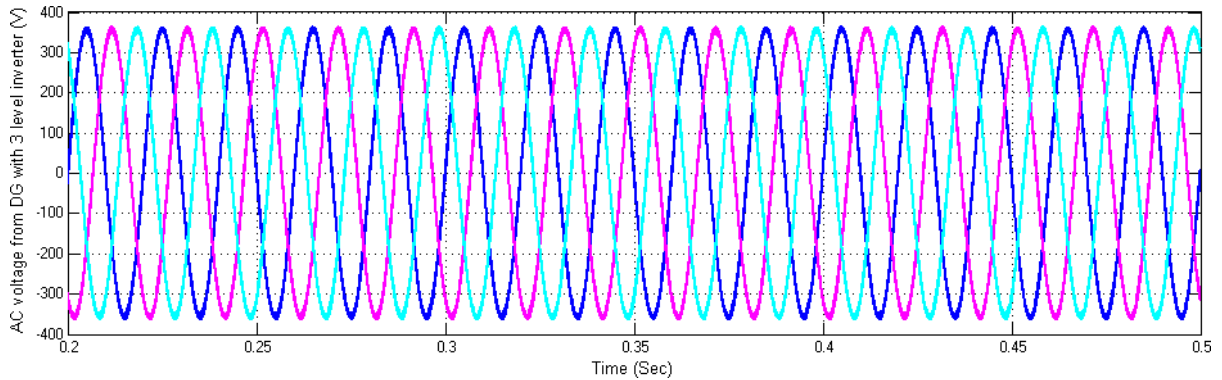

Figure 7: AC voltage from DG with 3-level inverter

Figure 7 shows the AC voltage delivered from DG using 3-level inverter topology. Voltage is balanced and maintained at constant peak of 360V.

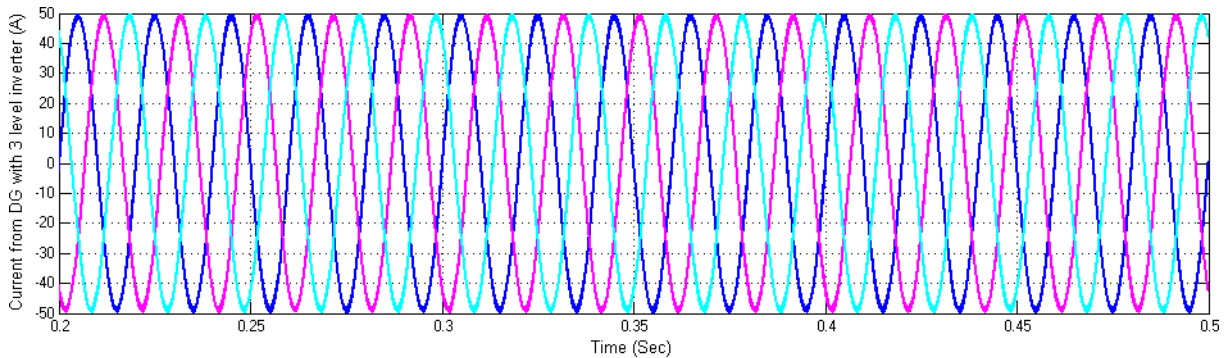

Figure 8: AC current from DG with 3-level inverter

Figure 8 shows the AC currents from DG to distribution grid integrated with help of 3-level inverter topology. Current is balanced and maintained at 50A constant peak.

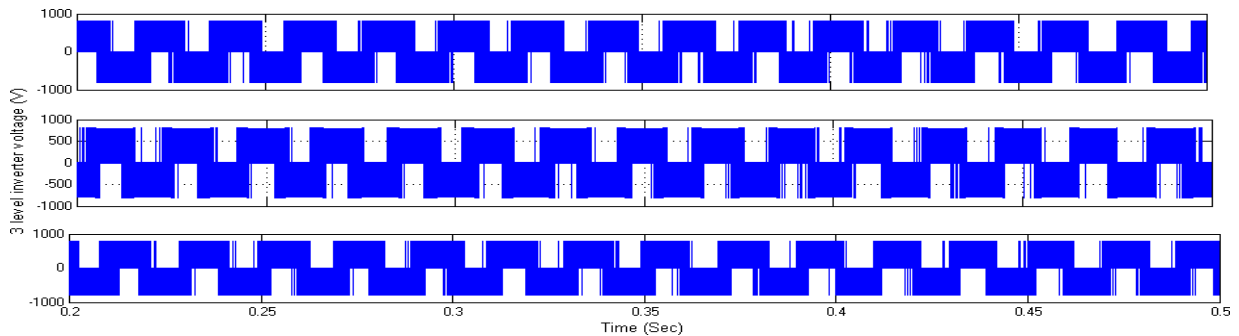

Figure 9: 3-level inverter output voltage

Fig 9 shows the output of 3-level inverter showing output alternating waveform in three steps.

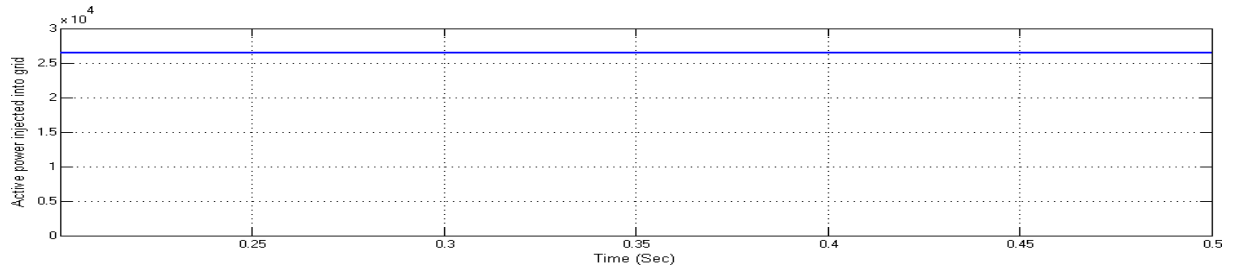

Figure 10: Active power injected into grid

Figure 10 shows the active power injected to grid from DG. Active power is constant and active power of 27KW is been injected to grid through 3-level inverter.

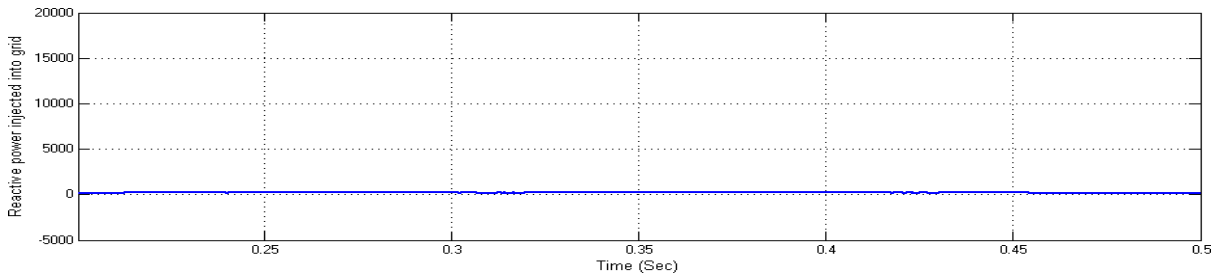

Figure 11: Reactive power injected into grid

Figure 11 shows the reactive power injected to grid from DG. Reactive power is constant and reactive power of 0W is been injected to grid indicating no reactive power generation or absorption to grid through 3-level inverter.

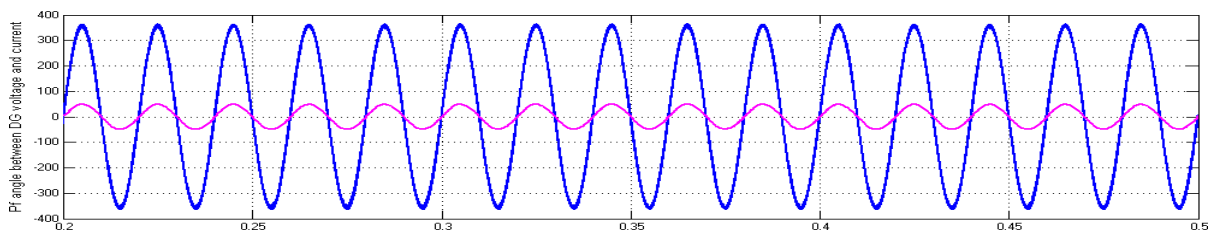

Figure 12: Power factor angle between DG voltage and current

Power factor angle between voltage and current of DG were shown in figure 12. The angle between voltage and current is nearer to zero indicating system maintained at nearer unity power factor

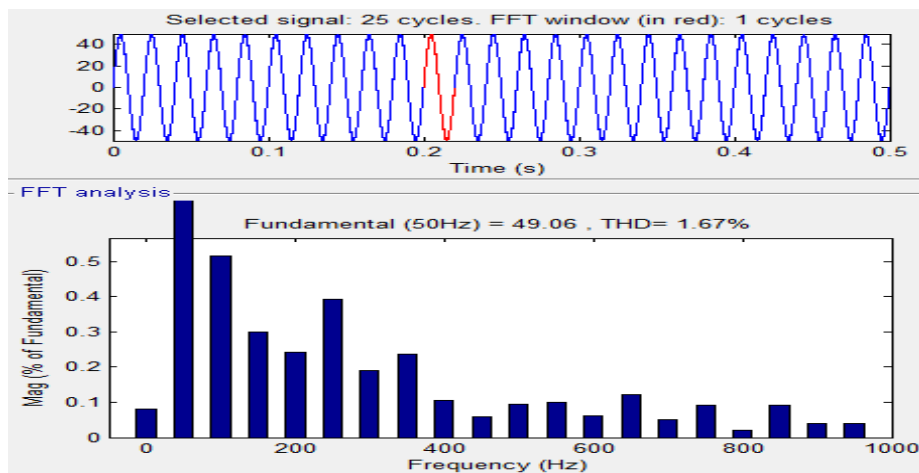

Figure 13: THD of DG current with 3 level inverter

Total harmonic distortion in current is shown in figure 13 indicating only 1.67% of THD in DG current which is less and maintained within nominal values.

Case 2: PV system integration through 3-level injecting both active and reactive power

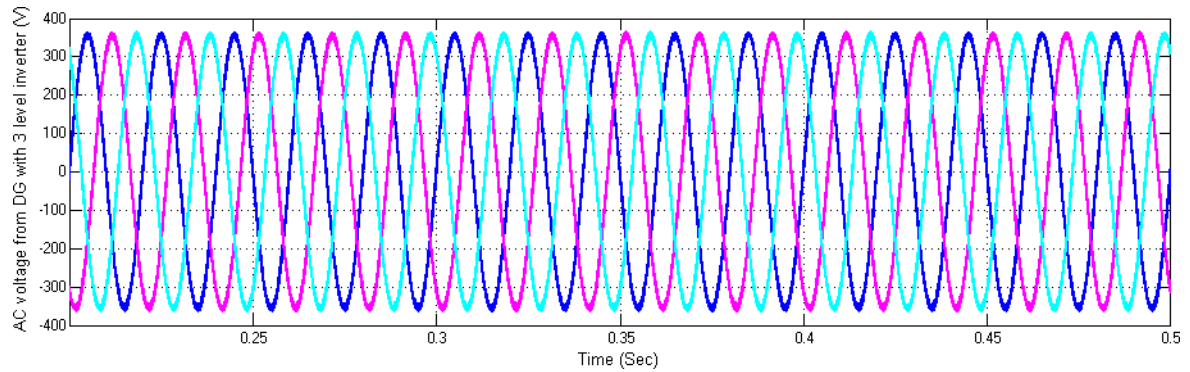

Figure 14: AC voltage from DG with 3-level inverter

Figure 14 shows the AC voltage delivered from DG using 3-level inverter topology delivering active and reactive powers. Voltage is balanced and maintained at constant peak of 360V

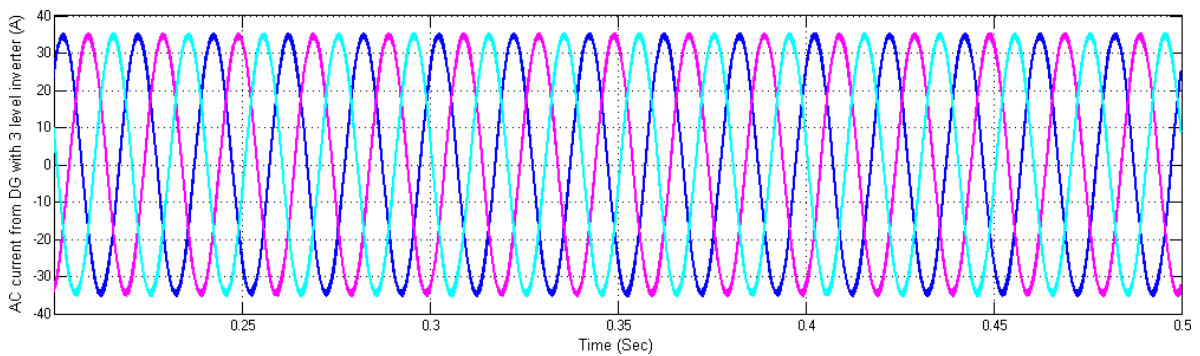

Figure 15: AC current from DG with 3 level inverter

Figure 15 shows the AC currents from DG to distribution grid integrated with help of 3-level inverter topology. Current is balanced and maintained with constant peak.

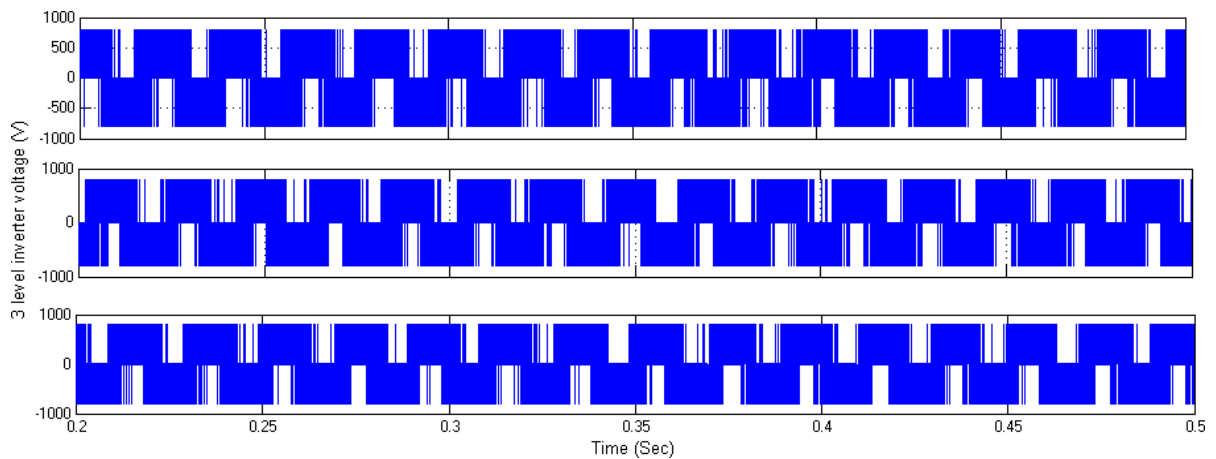

Figure 16: 3 level inverter voltage

Fig 16 shows the three-phase output of 3-level inverter showing output alternating waveform in three steps.

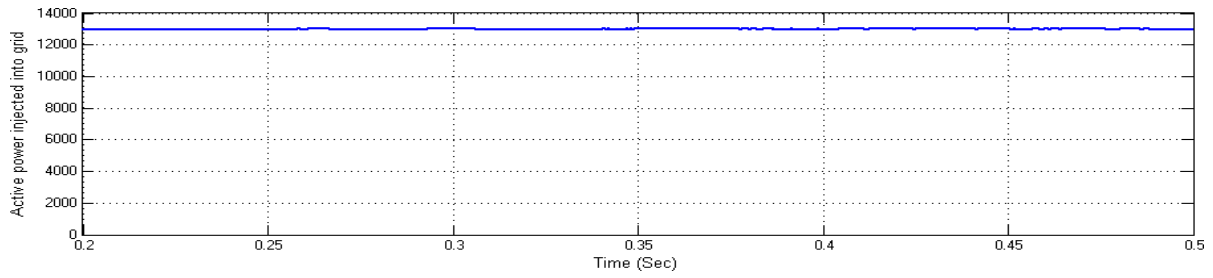

Figure 17: Active power injected into grid

Figure 17 shows the active power injected to grid from DG. Active power is constant and active power of 13KW is been injected to grid through 3-level inverter.

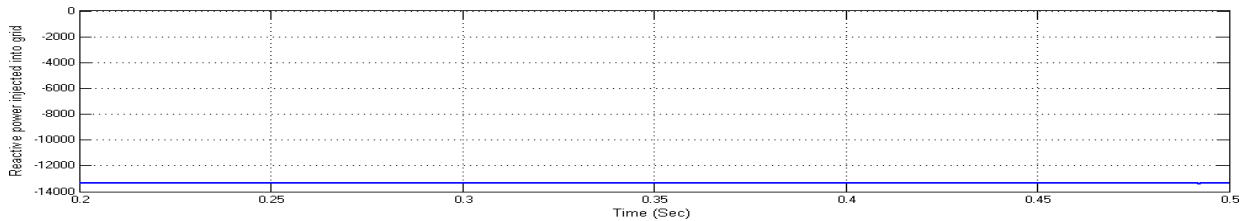

Figure 18: Reactive power injected into grid

Figure 18 shows the reactive power injected to grid from DG. Reactive power is constant and reactive power of 13KW is been injected to grid to grid through 3-level inverter.

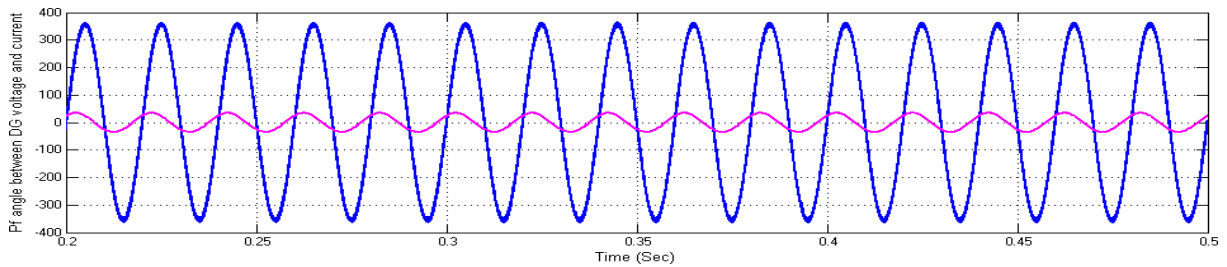

Figure 19: Power factor angle between DG voltage and current

Power factor angle between voltage and current of DG were shown in figure 19. The angle between voltage and current is not zero. When reactive power is been injected power factor angle varies and is shown in figure.

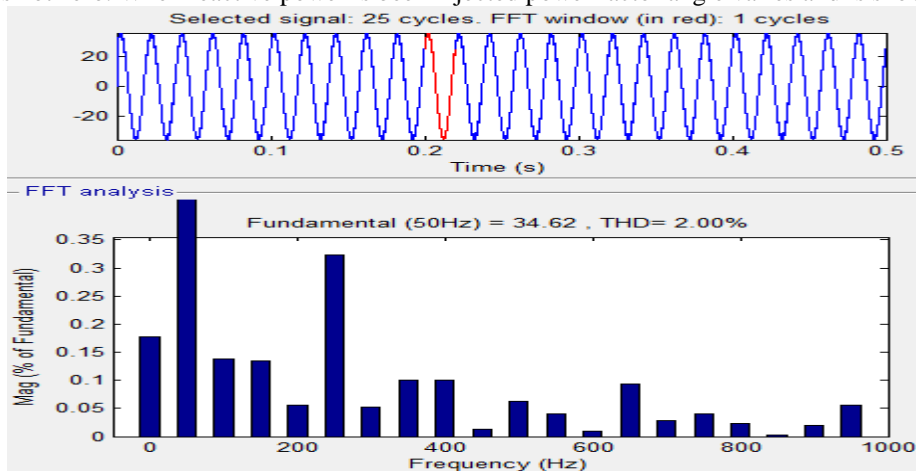

Figure 20: THD of DG current with 3 level inverter

Total harmonic distortion in current is shown in figure 20 indicating only 2.00% of THD in DG current which is less and maintained within nominal values.

Case 3: PV system integration through 5-level sending only active power

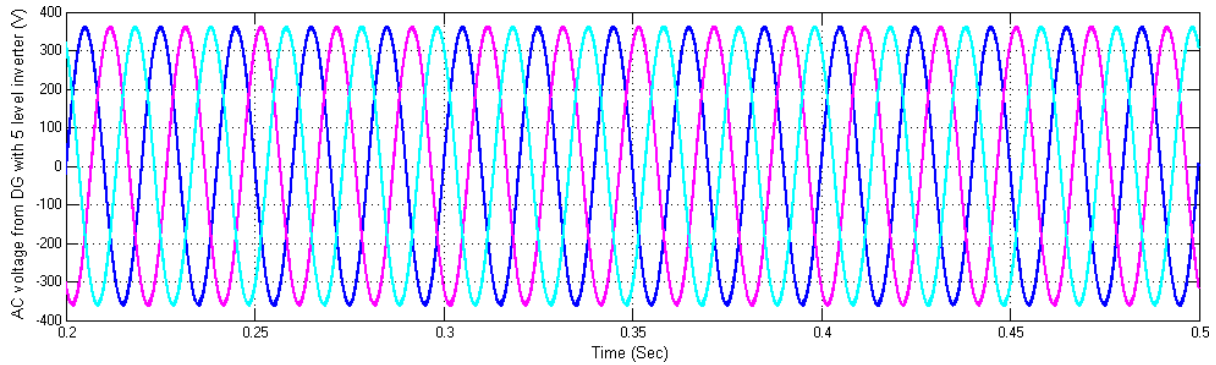

Figure 21: AC voltage from DG with 5-level inverter

Figure 21 shows the AC voltage delivered from DG using 5-level inverter topology. Voltage is balanced and maintained at constant peak of 360V.

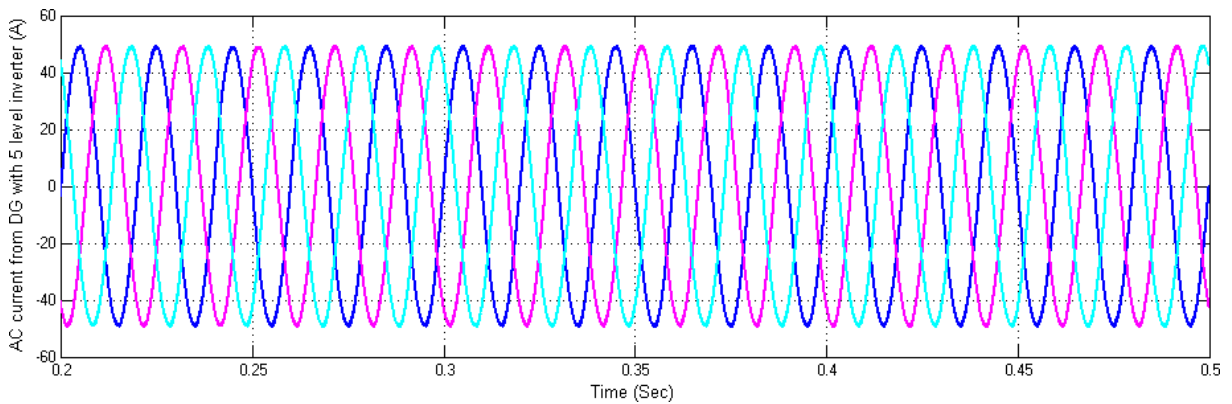

Figure 22: AC current from DG with 5-level inverter

Figure 22 shows the AC currents from DG to distribution grid integrated with help of 5-level inverter topology. Current is balanced and maintained with constant peak.

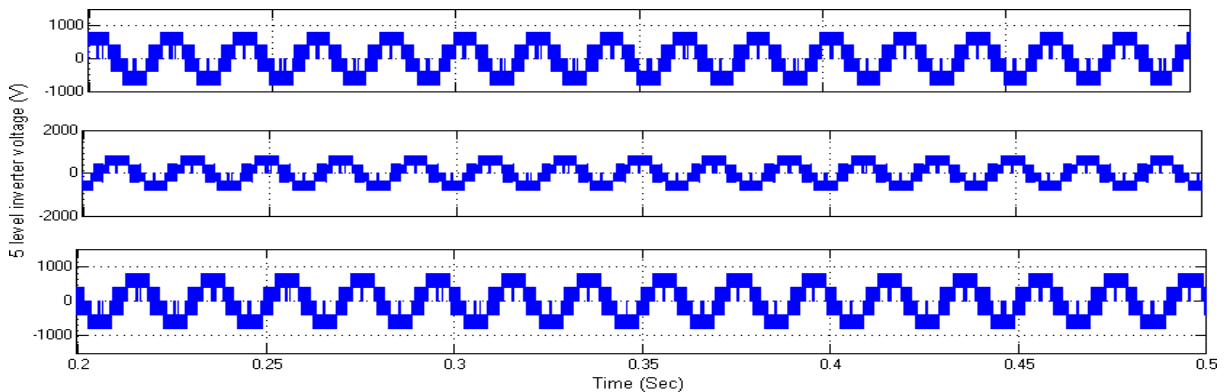

Figure 23: 5-level inverter output voltage

Fig 23 shows the three-phase output of 5-level inverter showing output alternating waveform in five steps.

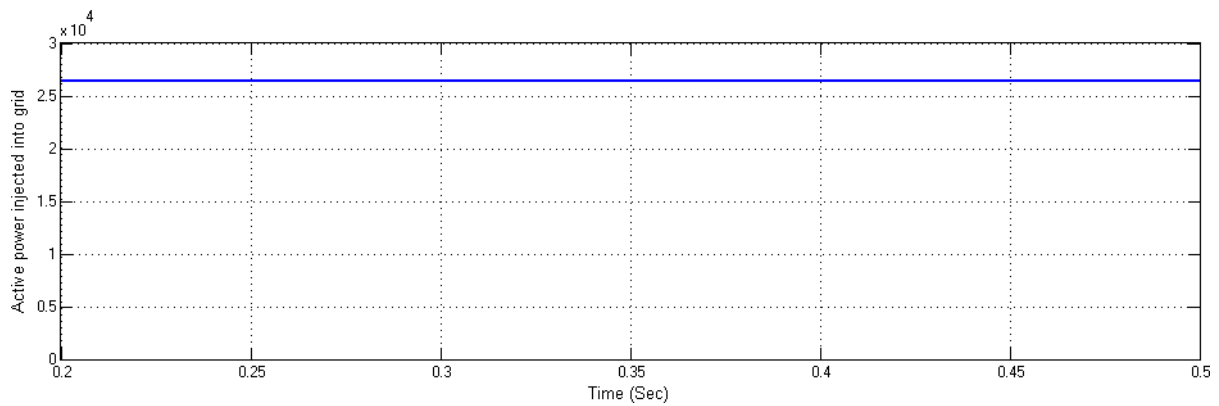

Figure 24: Active power injected into grid

Figure 24 shows the active power injected to grid from DG. Active power is constant and active power of 27KW is been injected to grid through 5-level inverter.

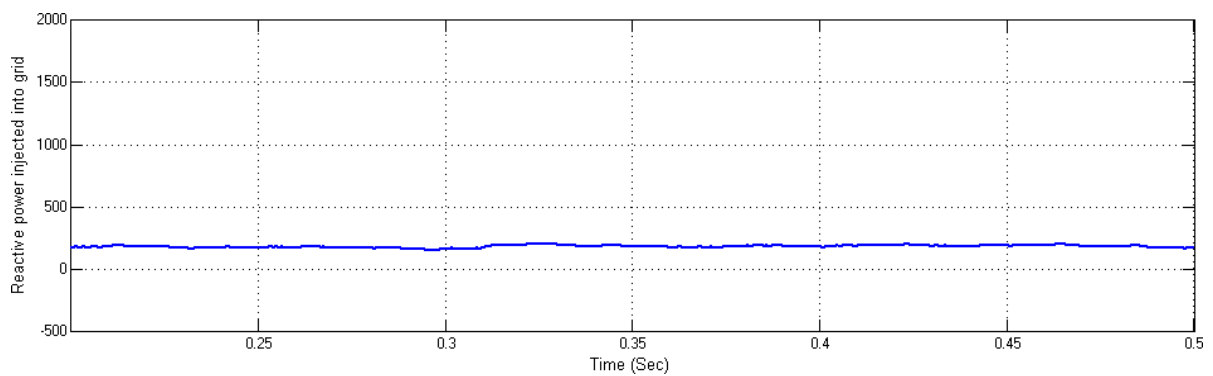

Figure 25: Reactive power injected into grid

Figure 25 shows the reactive power injected to grid from DG. Reactive power is constant and reactive power is not been injected to grid indicating no reactive power generation or absorption to grid through 5-level inverter.

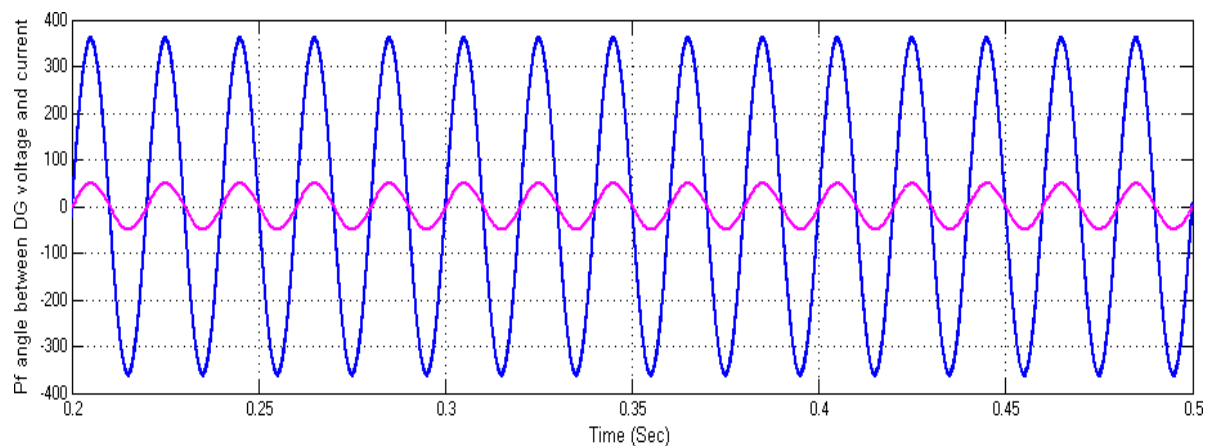

Figure 26: Power factor angle between DG voltage and current

Power factor angle between voltage and current of DG were shown in figure 26. The angle between voltage and current is nearer to zero indicating system maintained at nearer unity power factor when sending only active power from the DG.

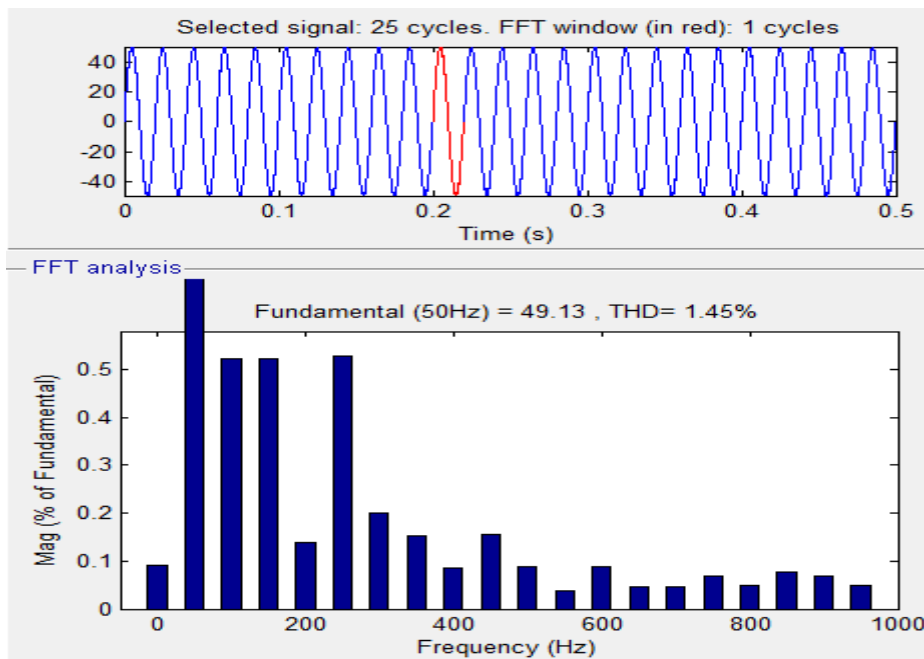

Figure 27: THD of DG current in 5 level inverter

Total harmonic distortion in current is shown in figure 27 indicating only 1.45% of THD in DG current which is less and maintained within nominal values.

Case 4: DG integration through 5-level inverter and sending both active and reactive powers

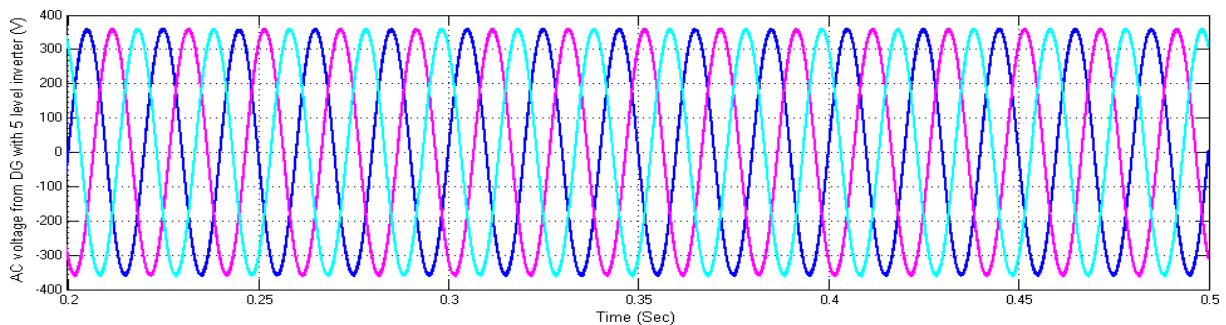

Figure 28: AC voltage from DG with 5-level inverter

Figure 28 shows the AC voltage delivered from DG using 5-level inverter topology. Voltage is balanced and maintained at constant peak of 360V.

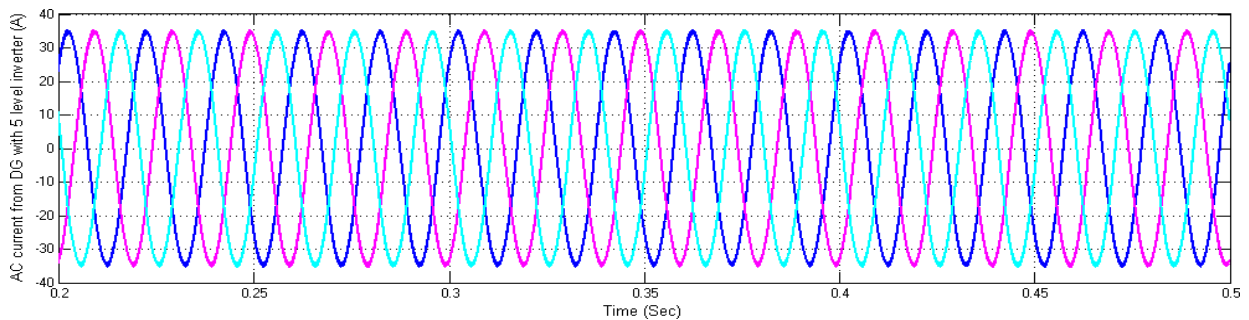

Figure 29: AC current from DG with 5 level inverter

Figure 29 shows the AC currents from DG to distribution grid integrated with help of 5-level inverter topology. Current is balanced and maintained with constant peak.

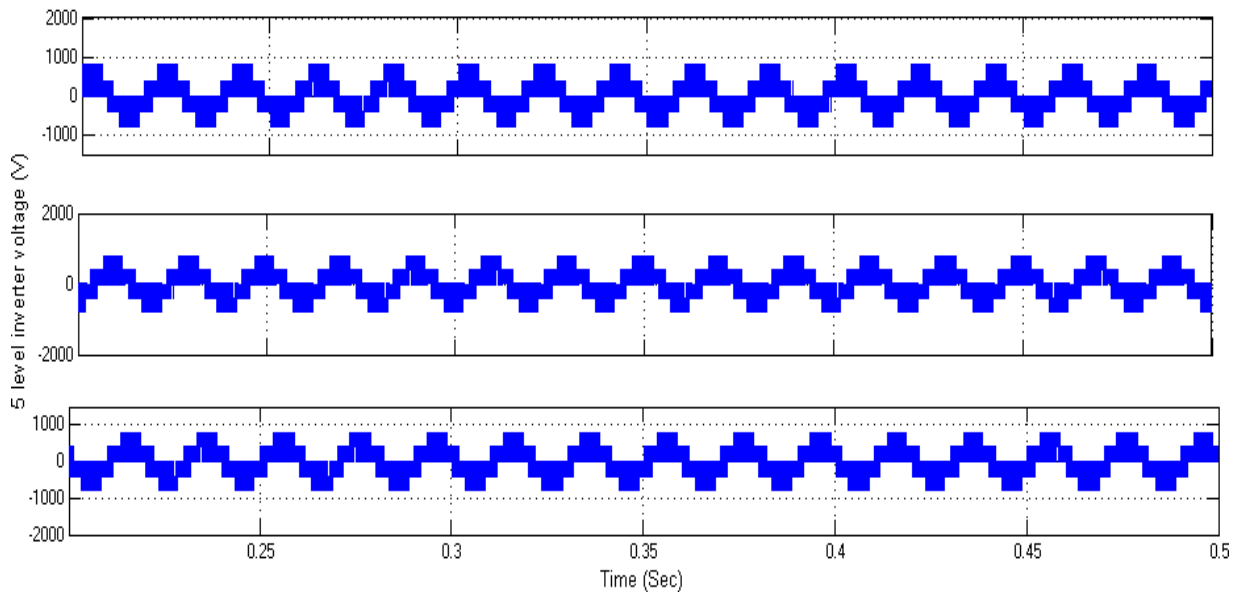

Figure 30: 5-level inverter output voltage

Fig 30 shows the output of three-phases in 5-level inverter showing output alternating waveform in five steps.

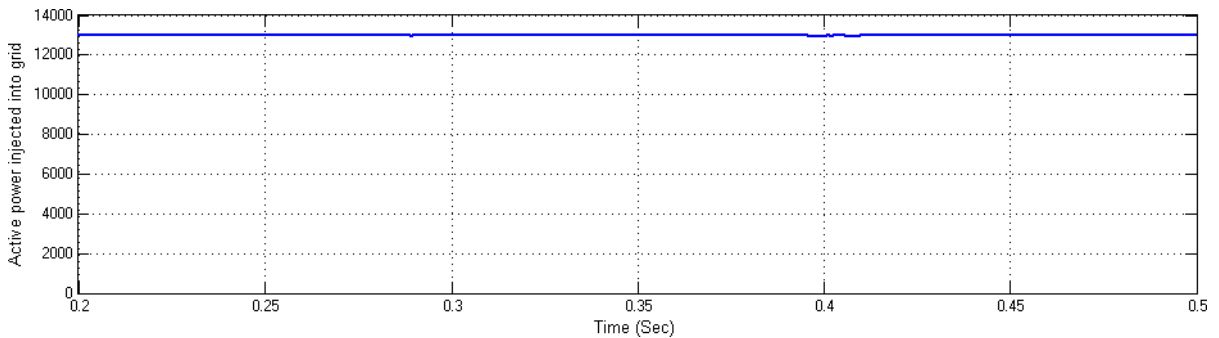

Figure 31: Active power injected into grid

Figure 31 shows the active power injected to grid from DG. Active power is constant and active power of 13KW is been injected to grid through 5-level inverter.

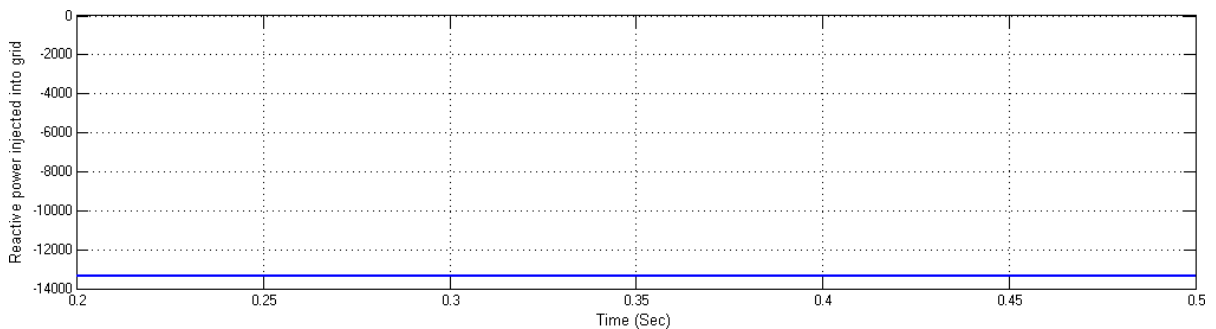

Figure 32: Reactive power injected into grid

Figure 32 shows the reactive power injected to grid from DG. Reactive power is constant and reactive power of 13W is been injected to grid through 5-level inverter.

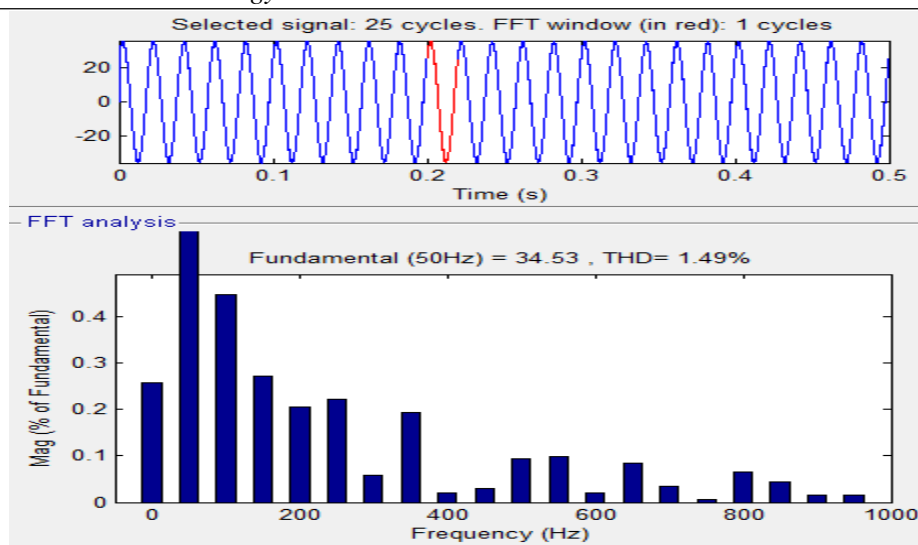

Figure 33: THD of DG current with 5 level inverter

Total harmonic distortion in current is shown in figure 33 indicating only 1.49% of THD in DG current which is less and maintained within nominal values.

VI. CONCLUSION

This paper presents the integration scheme of distributed generation to distribution grid through multi-level inverter. Multi-level inverters like three-level and five-level were explained and integration schemes with both topologies were explained. Results were presented for proposed work showing voltage and current in DG, output of inverter, THD in DG current and power factor angle between DG voltage and current. Inverter is controlled with simplified control strategy which was explained with integration scheme. With integration of DG through multi-level inverters, THD reduces and rate of change in voltage also reduces at load.

REFERENCES

- [1] A. Maroufmashat *et al.*, "Optimization of renewable powered hydrogen micro-grid; taking in to account economic criteria," *2016 IEEE Smart Energy Grid Engineering (SEGE)*, Oshawa, ON, Canada, 2016, pp. 252-256.
- [2] L. Wang, C. Cao and B. Chen, "Model-based micro-grid modeling and optimal PEV charging control," *2016 12th IEEE/ASME International Conference on Mechatronic and Embedded Systems and Applications (MESA)*, Auckland, New Zealand, 2016, pp. 1-6
- [3] A. Mudgal, J. Srivastava, K. Kumar and V. Dutta, "Implementation of PV-FC hybrid micro grid with grid interactive feature," *2016 IEEE 6th International Conference on Power Systems (ICPS)*, New Delhi, India, 2016, pp. 1-4.
- [4] N. Mourad and B. Mohamed, "Impact of increased distributed photovoltaic generation on radial distribution networks," *2016 International Conference on Control, Decision and Information Technologies (CoDIT)*, Saint Julian's, Malta, 2016, pp.292-295
- [5] N. G. Paterakis, O. Erdinç, I. N. Pappi, A. G. Bakirtzis and J. P. S. Catalão, "Coordinated Operation of Smart Households Comprising Electric Vehicles, Energy Storage and Distributed Generation," in *IEEE Transactions on Smart Grid*, vol. 7, no. 6, pp. 2736-2747, Nov. 2016.
- [6] K. C. Tseng; C. A. Cheng; C. T. Chen, "High Step-Up Interleaved Boost Converter for Distributed Generation Using Renewable and Alternative Power Sources," in *IEEE Journal of Emerging and Selected Topics in Power Electronics* , no.99,2016.
- [7] A. Salem, E. M. Ahmed, M. Ahmed, M. Orabi and A. B. Abdelghani, "Reduced switches based three-phase multi-level inverter for grid integration," *Renewable Energy Congress (IREC), 2015 6th International*, Sousse, 2015, pp. 1-6
- [8] S. H. Shehadeh, H. H. Aly and M. E. El-Hawary, "Photovoltaic multi-level inverters technology," *Electrical and Computer Engineering (CCECE), 2015 IEEE 28th Canadian Conference on*, Halifax, NS, 2015, pp. 648-655